Model 8400 Distribution Amplifier

TECHNICAL
DRAWINGS

ALL MODELS — SAFETY FIRST!

PLUG INTO 117V AC 50/60HZ 3-TERMINAL EARTH-GROUNDED OUTLETS ONLY!

This product is equipped with a 3-wire AC power cord and 3-terminal polarized plug for connection to mating 3-terminal safety-grounded AC outlets. The ground pin is connected directly to chassis for protection against electrical shock.

WARNING -To avoid electrical shock and equipment damage, do not remove covers from this instrument. There are no user adjustments inside. Potentially lethal voltages are present inside this unit. Do not expose this unit to water or any other liquids. Refer all repairs to qualified service engineers.

CONNECTING AND ENERGIZING - Read all instructions on connecting inputs, outputs and AC power before energizing this equipment. Generally it is best to connect all inputs and outputs before plugging into AC main. This procedure is safest for you, and it reduces the possibility of equipment damage in the event of any "hot chassis" conditions anywhere in the system.

AVOIDING DAMAGE - This equipment is designed to perform for many, many years. With proper care it will do so, but please, do not energize this unit until you have read the following safety instructions:

- (1) Do not connect any inputs or outputs to 117V AC line or to any piece of equipment that does not have a properly grounded chassis.
- (2) Complete all input and output connections before plugging into AC main.
- (3) Do not connect the output of a power amplifier into inputs or outputs of this unit.
- (4) Do not get water or any liquids inside this equipment.
- (5) Do not remove covers. Please refer service to authorized service engineers.
- (6) Connect to 117V AC 50/60Hz service only.
- (7) ENERGIZE LAST.

UNPACKING - Your equipment has been carefully packed to ensure its safety in transit. However, it is advisable to inspect this unit as soon as it is received. If damage is evident, contact the transportation company. Since the carton is necessary evidence for shipping damage claims, save it. *Save the carton anyway; it is the safest way to protect your unit should you want to ship it at a later date.*

 Wheatstone Corporation

 AUDIOARTS® ENGINEERING

600 INDUSTRIAL DRIVE, NEW BERN, NORTH CAROLINA 28562 (252-638-7000/FAX 252-637-1285)

CONNECTING TO THE MODEL 8400

POSSIBLE CONFIGURATIONS

INTRODUCTION

The Model 8400 DA is designed for versatility. It is essentially comprised of four DA sections, each with one mono input and four mono outputs. Two additional input connectors make it easy to reconfigure the Model 8400 to be an eight output stereo DA.

CONNECTIONS PROVIDED

The Model 8400 has four DA sections, **A**, **B**, **C**, and **D**. Each section has a 3-pin input connector and four 3-pin output connectors, to provide balanced signals in and out. Two additional connectors, **A-to-B** and **C-to-D**, provide an easy way of linking sections together. Connector **A-to-B** is internally connected in parallel with the **A** input connector, and connector **C-to-D** is internally connected in parallel with the **C** input connector.

Note that, as you face the rear panel of the Model 8400, you will see the connectors. Inputs are on the left (viewed from the rear) and are, in order, the RIGHT inputs (**D**, **C-to-D**, and **C**) and the LEFT inputs (**B**, **A-to-B**, and **A**). The outputs come next, grouped in fours. They are, in order, the RIGHT outputs (**D8**, **D7**, **D6**, **D5**, **C4**, **C3**, **C2**, and **C1**), and the LEFT outputs (**B8**, **B7**, **B6**, **B5**, **A4**, **A3**, **A2**, and **A1**). For each connector, the pin on the left is the LOW side, the pin in the middle is the SHIELD, and the pin on the right is the HIGH side.

CONFIGURING AS TWO 1X8 DAs (EIGHT OUTPUT STEREO)

Start by making two short jumpers for balanced signals. Each jumper is comprised of two 3-pin connectors and a short piece of shielded pair wire. Connect LOW to LOW, HIGH to HIGH, and SHIELD to SHIELD. Attach one jumper to connect the **A-to-B** connector to the **B** connector, and the other jumper to connect the **C-to-D** connector to the **D** connector. In this manner, sections **A** and **B** are linked together, and sections **C** and **D** are linked together. Now, connect the left channel of the stereo signal you want to distribute to the **A** input, and connect the right channel of the signal to the **C** input. The left channel signal now becomes available at outputs **A1**, **A2**, **A3**, **A4**, **B5**, **B6**, **B7**, and **B8**, and the right channel signal now becomes available at outputs **C1**, **C2**, **C3**, **C4**, **D5**, **D6**, **D7**, and **D8**.

CONFIGURING AS FOUR 1X4 DAs (MONO)

Section **A** performs as a 1X4 DA. Connect the mono source you want to distribute to the **A** input. The same signal is available at outputs **A1**, **A2**, **A3**, and **A4**. In a like manner, section **B** also performs as a 1X4 DA. Connect a second source to the **B** input, and that signal becomes available at outputs **B5**, **B6**, **B7**, and **B8**. Similarly, a third source connected to the **C** input becomes available at outputs **C1**, **C2**, **C3**, and **C4**, and a fourth source connected to the **D** input becomes available at outputs **D5**, **D6**, **D7**, and **D8**. Note that the source signals may or may not be related. For example, you can use this configuration to distribute two stereo sources, four mono sources, or even one stereo source and two mono sources. In this configuration, the **A-to-B** and **C-to-D** inputs are not used.

OTHER POSSIBLE CONFIGURATIONS

By connecting the **A-to-B** connector to the **B** connector, but not using a second jumper to connect **C-to-D** to **D**, you can create three mono DAs, one being 1X8 and the other two being 1X4.

Although not as easy to implement, you can also create a 1X16 mono DA. This, however, requires you to parallel connections from the source to both the **A** and **C** inputs of a Model 8400 which has been configured for eight output stereo. It is important to note that the Model 8400 does not provide any additional connectors to parallel the **A** and **C** inputs, so you will need to do that externally. The 3-pin connectors do not lend themselves to using two wires per pin, so you will need to make the parallel connection another way. One suggestion is to use a screw type terminal block.

UNBALANCED CONNECTIONS

Whenever possible, use balanced connections. If you must use unbalanced connections, follow the rules outlined here.

To connect unbalanced sources to the Model 8400 inputs, use two conductor shielded wire. At the Model 8400 input, connect the cable as normal, red wire to HIGH, black wire to LOW, and SHIELD to SHIELD. At the unbalanced source, connect the source's hot connection to the red wire, and its ground to both the black wire and the shield. If you later change the source equipment to one that has a balanced output, you only need to rewire the equipment end to balanced configuration.

To connect the Model 8400 outputs to unbalanced destination inputs, connect the HIGH output to the destination's hot connection, and the SHIELD output to the destination's SHIELD input. The Model 8400 output's LOW connection must remain floating. Again, it is recommended that you use a two conductor shielded cable, so that, if the destination equipment is upgraded to a balanced input device, minimum rewiring is required to match the new equipment.

Model 8400 Connector Pins

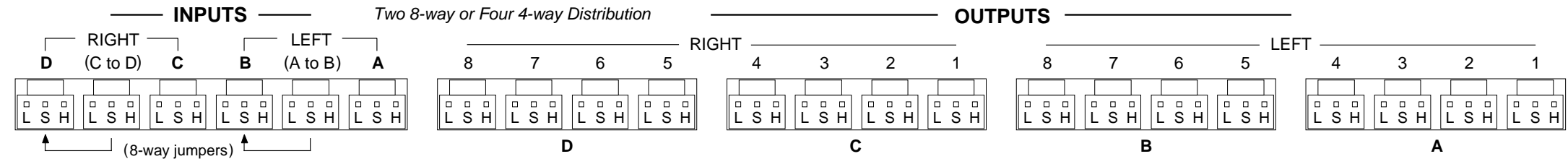

CAUTION - TO AVOID ELECTRIC SHOCK
REFER SERVICE TO QUALIFIED TECHNICIAN

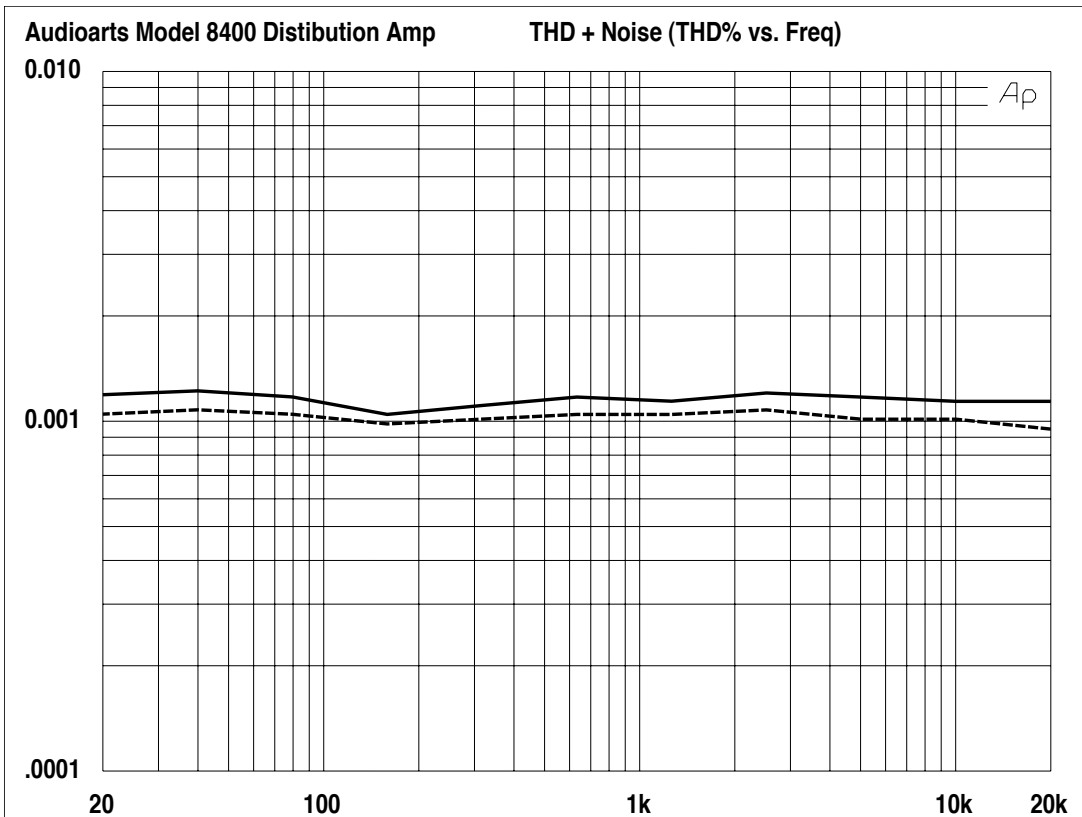
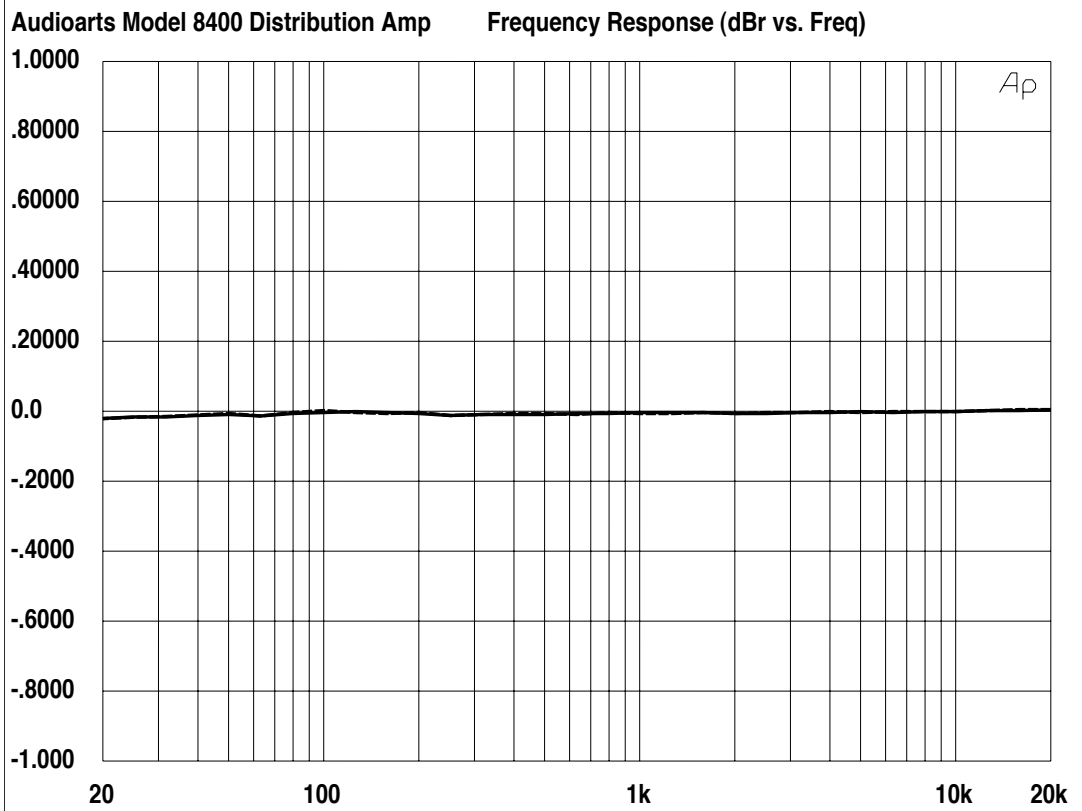

PERFORMANCE SPECIFICATIONS

DYNAMIC RANGE

unity gain 121dB

FREQUENCY RESPONSE

20Hz–20KHz +0,-0.1dB

OUTPUT CROSSTALK

1KHz –105dB

20KHz –80dB

THD + N (20Hz–20KHz)

+4dBu 0.002%

+24dBu 0.001%

IMD (SMPTE)

+4dBu 0.002%

+24dBu 0.003%

DIM

+4dBu 0.002%

+24dBu 0.001%

SLEW RATE

15V/ μ S

MAXIMUM INPUT

+28dBu

MAXIMUM OUTPUT

+28dBu

HEADROOM

ref +4dBu 24dB

GAIN TRIM RANGE

(-1dB to +20dB) 21dB

MAXIMUM GAIN

16dB

NOISE

–95dBu

CMRR

60Hz–20KHz –50dB

Specifications and features subject to change without notice.

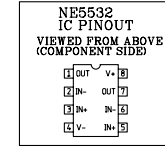
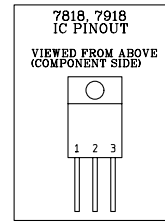
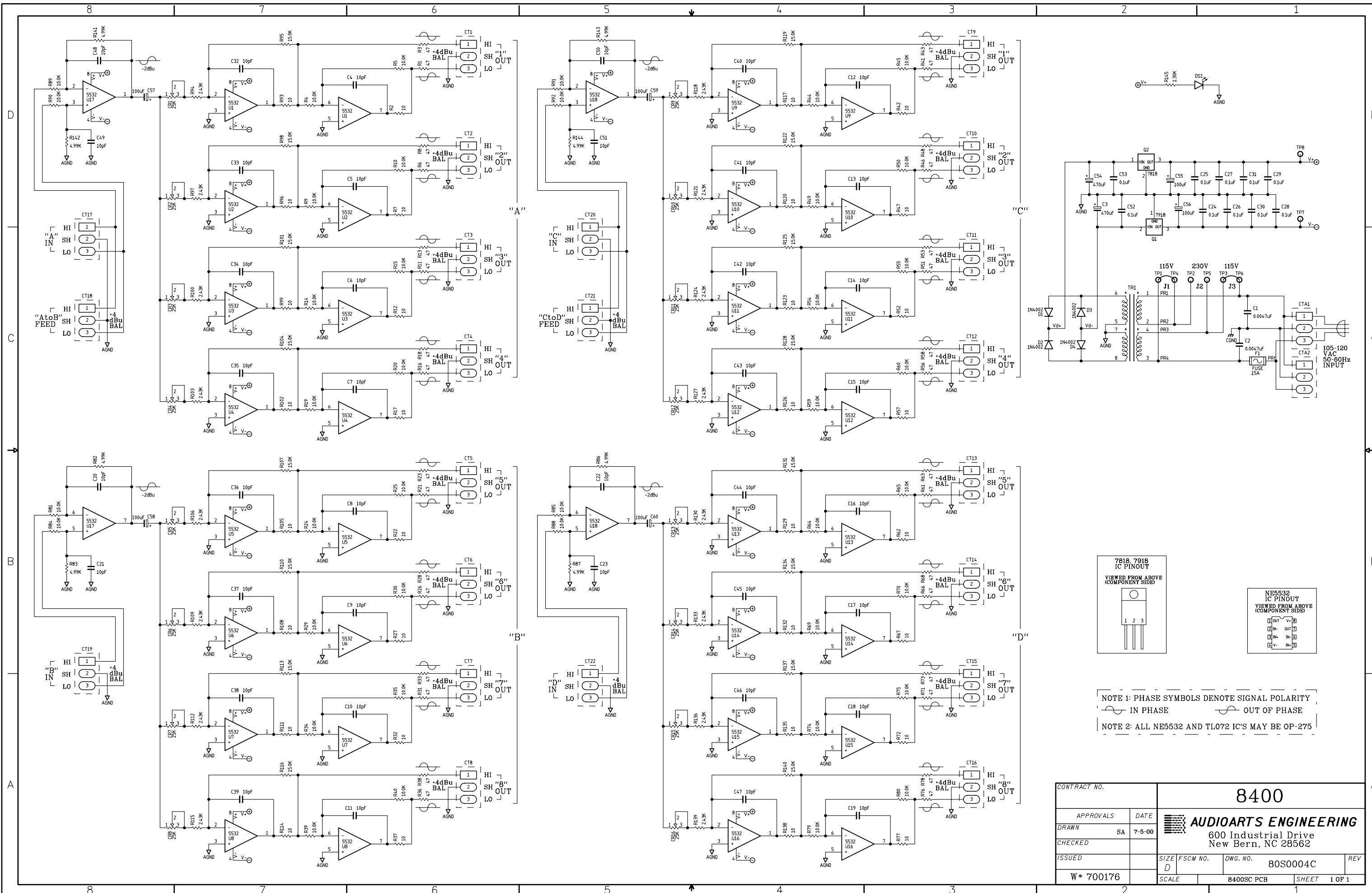

NOTE 1: PHASE SYMBOLS DENOTE SIGNAL POLARITY
 ~~~~~ IN PHASE      ~~~~~ OUT OF PHASE

NOTE 2: ALL NE5532 AND TL072 IC'S MAY BE OP-275

|              |           |                                                                            |            |                   |     |
|--------------|-----------|----------------------------------------------------------------------------|------------|-------------------|-----|
| CONTRACT NO. |           | <b>8400</b>                                                                |            |                   |     |
| APPROVALS    | DATE      | <b>AUDIOARTS ENGINEERING</b><br>600 Industrial Drive<br>New Bern, NC 28562 |            |                   |     |
| DRAWN        | SA 7-5-00 |                                                                            |            |                   |     |
| CHECKED      |           |                                                                            |            |                   |     |
| ISSUED       |           |                                                                            |            |                   |     |
| W# 700176    |           | SIZE D                                                                     | FSCM NO.   | DWG. NO. 80S0004C | REV |
|              |           | SCALE                                                                      | 8400SC PCB | SHEET 1 OF 1      |     |

8400 Distribution Amplifier Schematic - Sheet 1 of 1



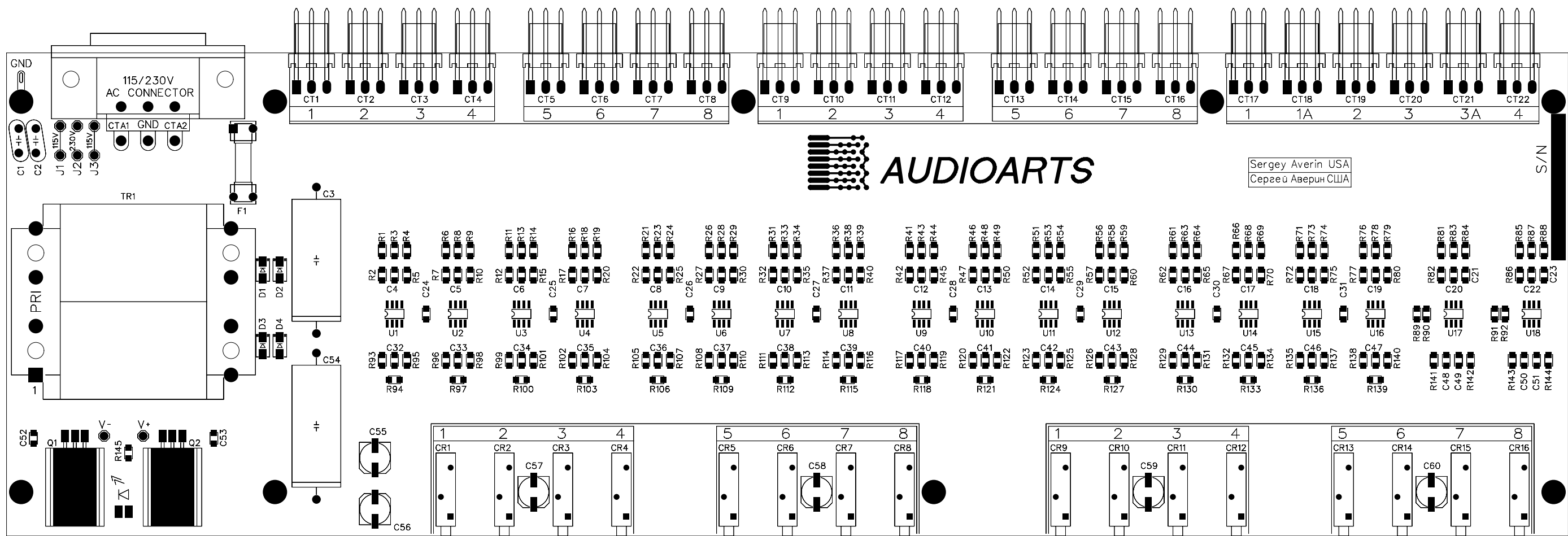

**AUDIOARTS**

Sergey Averin USA  
Сергей Аверин США

S/N